

A-A (1:1)

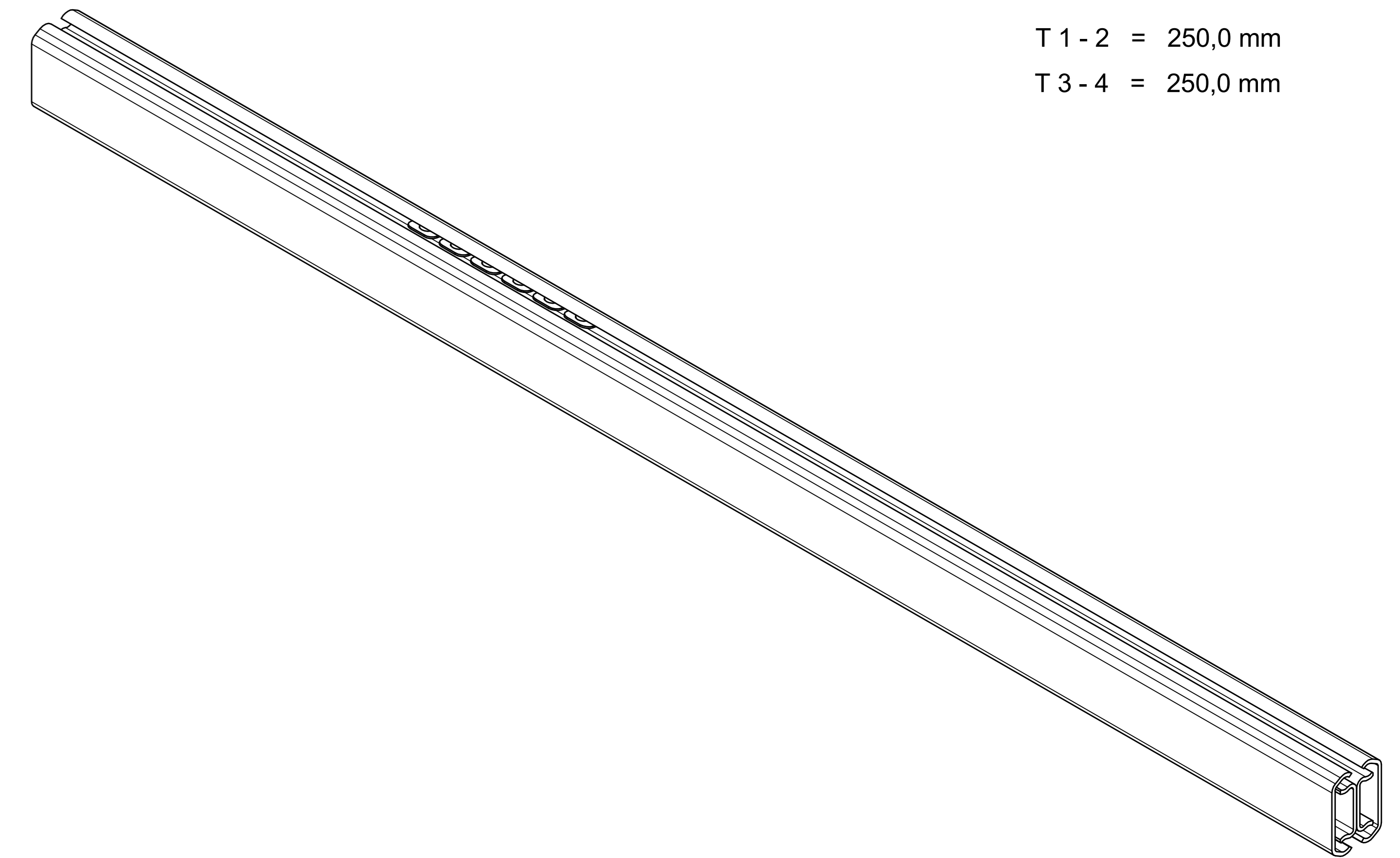

T 1 - 2 = 250,0 mm
T 3 - 4 = 250,0 mm

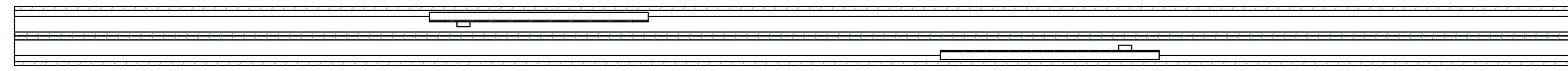
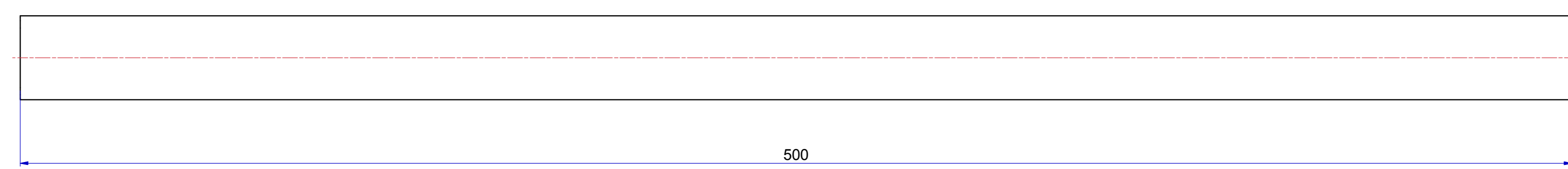
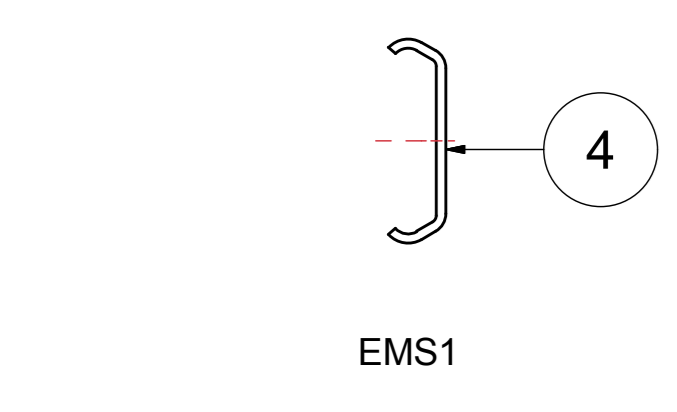
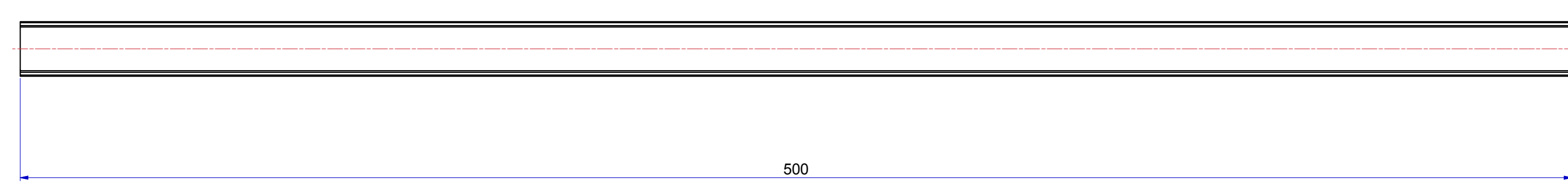
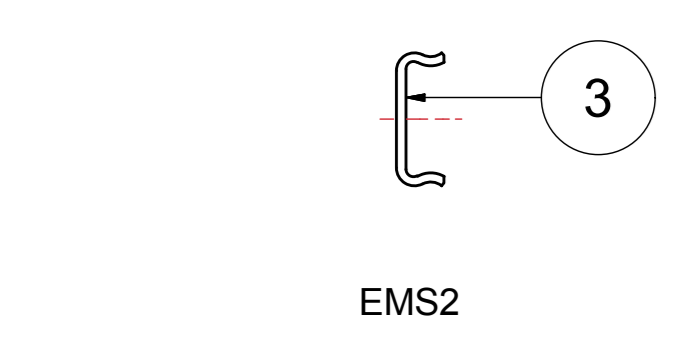
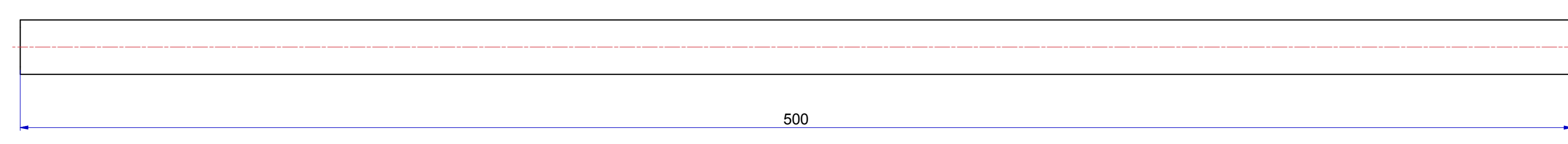
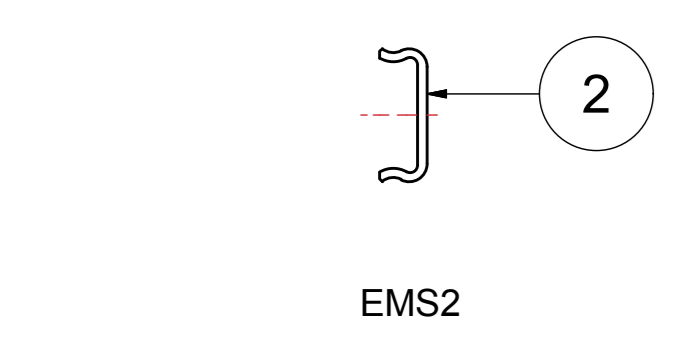
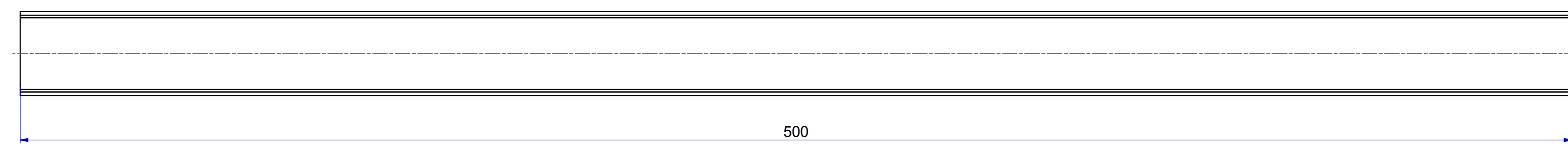
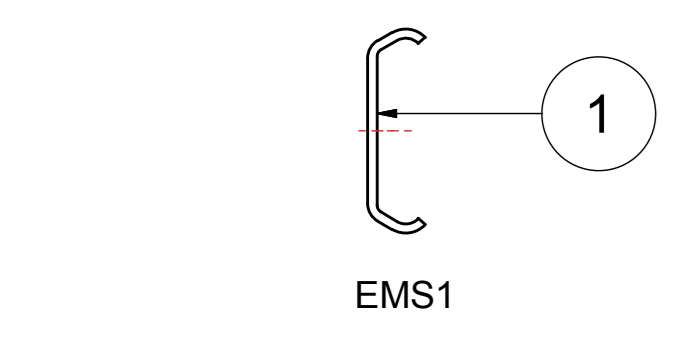
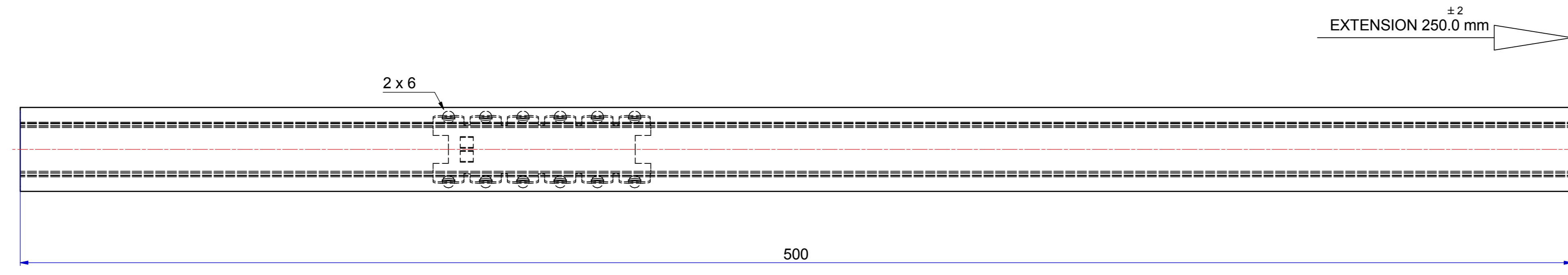
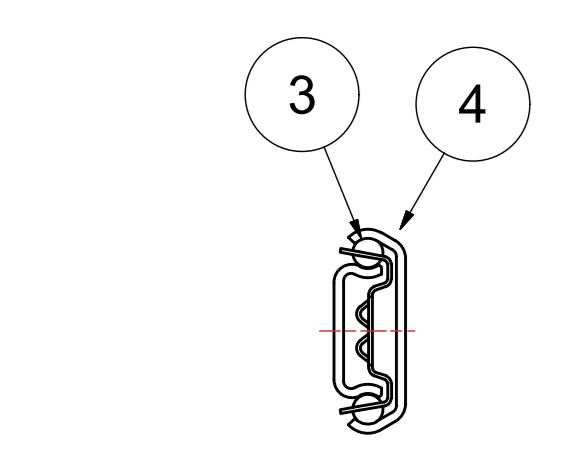
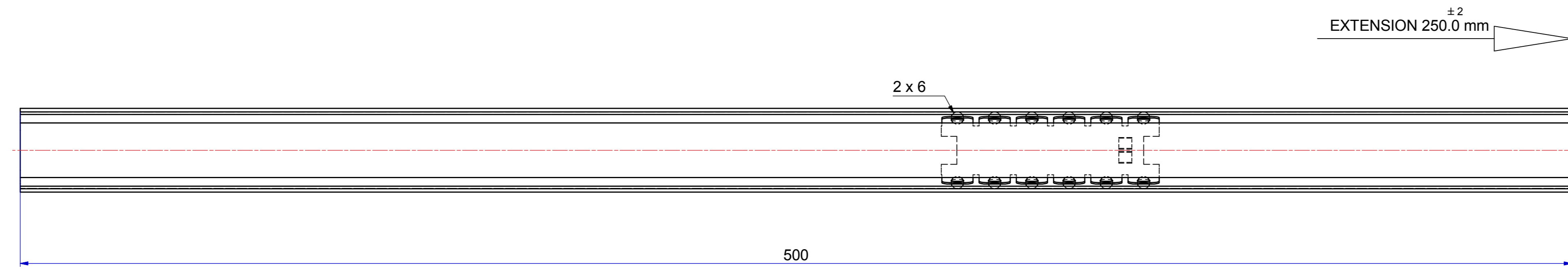
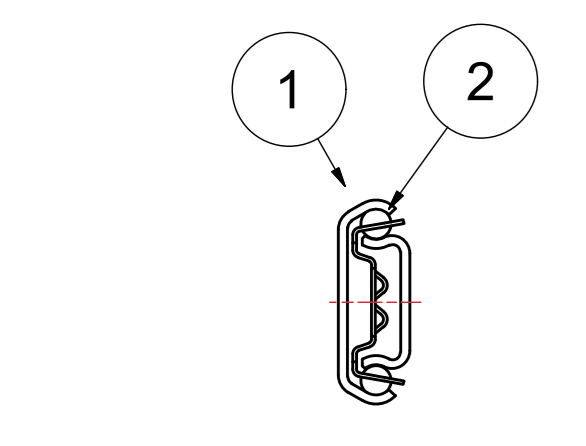
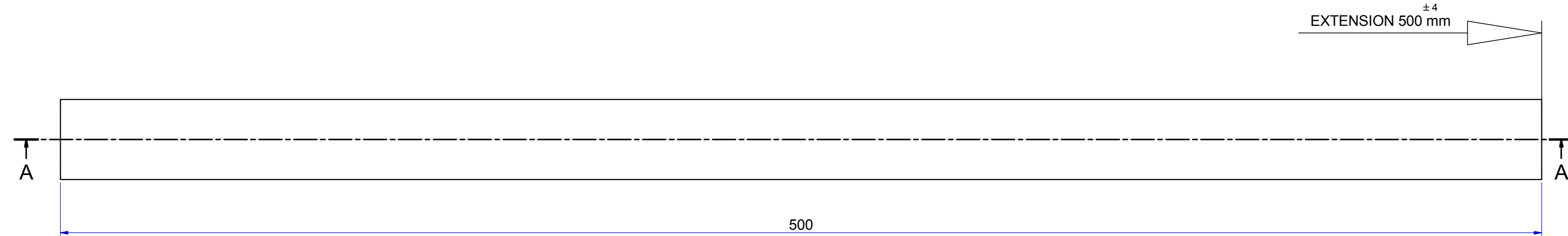
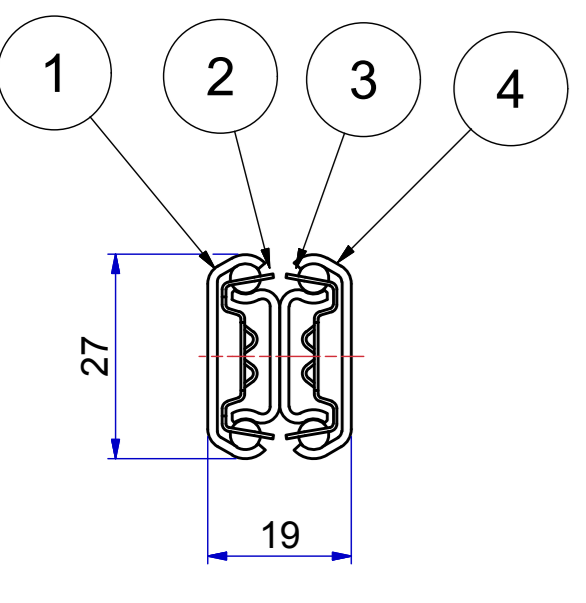

OTHER DIMENSIONS NEEDED?
CUSTOM MADE SLIDES AVAILABLE UPON REQUEST.

Right hand slide = Left hand slide.
Dimensions between marks are guide dimensions.
Thomas Regout Int. B.V. reserves the right to alter non-customer specific specifications without notice.

Designer: W.Jans	Gen.Tol.Dim: ±	Third angle projection	Material
Date: 9-6-2015	Gen.Tol.Angle: ±		Treatment
Approver:	Gen.Roughness: Ra		Draw type: Customer
Date:	Units: mm/deg.	Scale: 1:1	Type
Description: DUBBELE EMS 500.0 / 500.0 (19.0mm)			
Format: A0	THOMAS REGOUT INTERNATIONAL B.V.	Item No. DOUBLE EMS	Revision 00
© THOMAS REGOUT INTERNATIONAL B.V. Industrieweg 40, 6219 NR, Maastricht, The Netherlands, +31 (0)43 251 66 66 All rights are reserved.			