



Industry
solutions in movement



Thomas Regout International B.V. offers a broad range of sliding solutions that help move your application in any direction: horizontal, vertical and diagonal.

In our long history we have grown into the company we are today: a major innovative player in automotive and industrial markets, as well as in furniture and professional storage. We are continuously broadening our product range with new product groups, features and other solutions to fulfil your needs.

Industry

Thomas Regout International B.V. is a global supplier in the design and production of telescopic slides for a wide range of industrial equipment applications. We offer an extensive line of unique features to meet the specific demands of our customers. In our own R&D department we design high quality innovative sliding systems. If required, tailor made by co-creating with our customers. Our slides are maintenance free, characterized by a long life time quality and suitable for high load capacities.

Our main focus is to be and to remain the best quality partner for our customers in mutual beneficial partnerships: a partnership that adds value and strengths to your and our organization.



ATM



Vending & Self-Checkout machines



Electro Technical

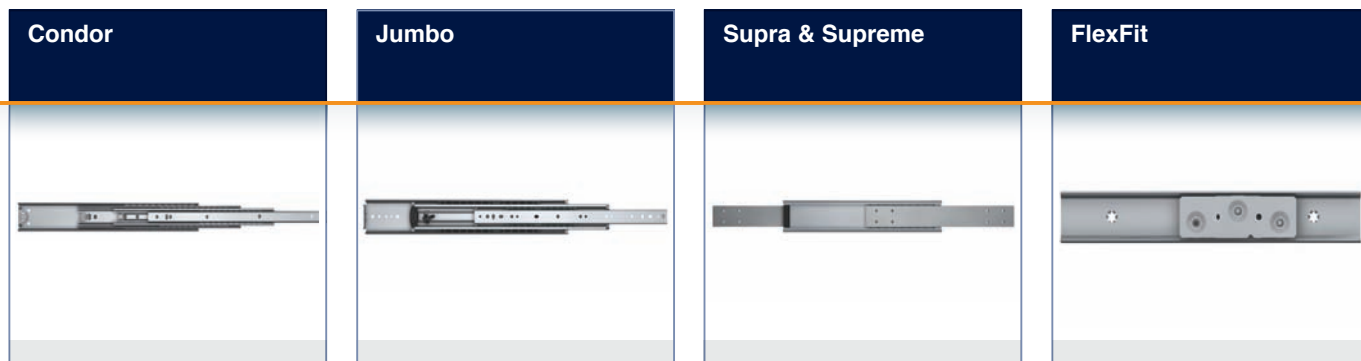

Products

Our heavy duty linear movement products are uniquely designed to offer the highest degree of rigidity, robustness, and includes high quality components to guarantee a long life cycle.

Supra & Supreme

The Supra and Supreme range provide a highly accurate and smooth running movement, under considerable loading up to 2100 kg. Available in steel, aluminum and stainless steel.

Condor The Condor is a 4 beam slide designed to offer a 150% to 180% extension. With these specifications the Condor is most suitable for applications in ATM and ticketing machines.

Jumbo The Jumbo is very robust and rigid due to the material thickness. This roll formed, extra heavy duty telescopic slide exceeds a load capacity of 300 kg with a minimum of deflection. The Jumbo is used in loading platforms, special vehicles and tooling cabinets.

FlexFit The FlexFit guide combines a profile and a carrier that enables multiple motion options. The different types are suited for different load capacities and can be used in vertical, horizontal and diagonal direction. Typical applications for the FlexFit are vending machines and sliding doors.



“We co-create together with our customers and therefore offer custom-made solutions that exactly fit their needs.”

Ronald (Research & Development)





Thomas Regout International B.V.







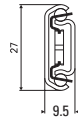
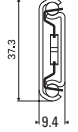
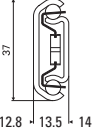
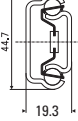
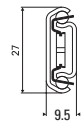
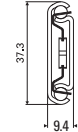
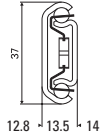
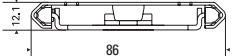
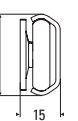
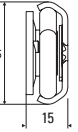
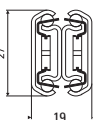
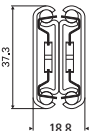
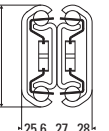

Industrieweg 40
6219 NR Maastricht
The Netherlands

T. +31 (0)43 351 66 66
F. +31 (0)43 351 66 99

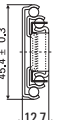

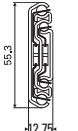

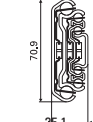
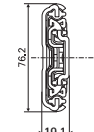
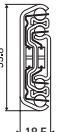
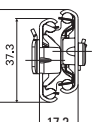
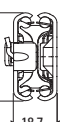

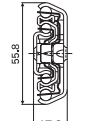
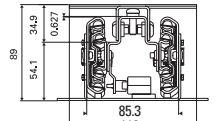
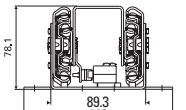
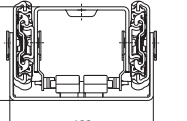
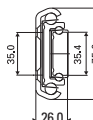
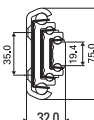
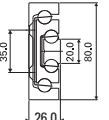
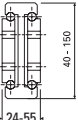
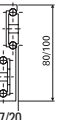

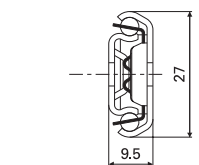

E. sales@thomasregout.com

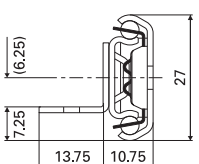
www.thomasregout.com

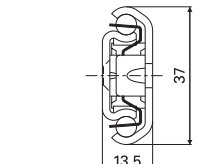

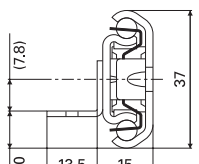

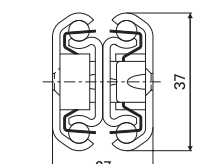

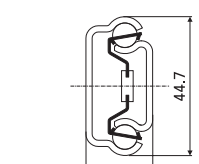



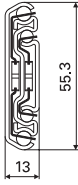

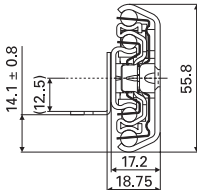

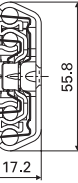
custom made slides									
SINGLE EXTENSION	Junior 10 kg	Ems 30 kg	Leon 41 kg	Finn 62 kg	Ado 73 kg (bottom mount 60 kg)				
									
SINGLE EXTENSION TWO WAY <small>Length, travel and weight are customer specific</small>	Ems	Leon	Finn	HAS / Monte		FlexFit 1529	FlexFit 1537		
									
FULL EXTENSION	Double Ems 23 kg	Double Leon 34 kg	Double Finn 55 kg	Allman 25 kg	Sten 45 kg	Solar 90 kg	Tricom 90 kg	Ulf HD 115 kg	Titan 156 kg
									
FULL EXTENSION TWO WAY <small>Length, travel and weight are customer specific</small>	Condor 70 kg	Jumbo 310 kg	FULL EXTENSION ALUMINIUM			Alu 40 kg	Hybrid * Double Leon 40 kg	Hybrid ** Double Leon 70 kg	Hybrid ULF HD 60 kg
									
FULL EXTENSION TWO WAY <small>Length, travel and weight are customer specific</small>	Bilex	LARDER UNIT			Larder Unit Wood 80-120 kg	Larder Unit Steel 80-120 kg	Larder Unit Heavy Duty 300 kg		
									
SUPER HEAVY DUTY	Supra TR-7526 387 kg	Supra TR-7532 250 kg	Supra TR-8026 330 kg aluminium			Supreme 50 - 2100 kg	Supreme S-design slide 150 - 420 kg		
									
<p>Technical specifications:</p> <p>Mentioned load capacities are based on 100.000 cycles. Static load capacities (10.000 cycles) available on request.</p> <p>Installation width per slide + 0,5 mm for optimal movement.</p> <p>* D. Leon Hybrid based on 20.000 cycles, length 300 - 500 mm</p> <p>** D. Leon Hybrid HD based on 30.000 cycles, length 300 - 500 mm</p>									

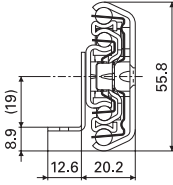

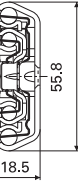
	telescopic slide single extension slides	technical drawing	description			load capacity			art. nr.	fixation	
			length mm	travel mm		cycles 10.000	cycles 50.000	cycles 100.000			
TR - 2710 EMS 1			300	210		22 kg		17 kg	109042F	Cabinet side	
			350	240		26 kg		20 kg	109043F	Metal: M4 / ISO 7380	
			400	290		26 kg		20 kg	109044F	Wood: 4,0 / DIN 7997	
			450	340		26 kg		20 kg	109052F		
			500	370		28 kg		22 kg	109046F	Drawer side	
									Metal: M4 / DIN 965		
									Wood: 3,5 / DIN 7997		
TR - 2711 EMS 2			300	210		22 kg		17 kg	109049F	Cabinet side	
			350	240		26 kg		20 kg	109050F	Metal: M4 / ISO 7380	
			400	290		26 kg		20 kg	109051F	Wood: 4,0 / DIN 7997	
			450	340		26 kg		20 kg	109052F		
			500	370		28 kg		22 kg	109053F	Drawer side	
			550	420		23 kg		18 kg	109054F	Metal: M3 / DIN 7985 / ISO 7045	
			600	460		23 kg		18 kg	109055F	Wood: 3,0 / DIN 7997	
TR - 3714 FINN 2			300	205		78 kg		60 kg	107230F	Cabinet side	
			350	239		63 kg		49 kg	107231F	Metal: M4 / DIN 7984	
			400	289		54 kg		42 kg	107232F	M4 / M5 / ISO 7380	
			450	339		46 kg		36 kg	107233F	Wood: 5,0 / DIN 7997	
			500	373		54 kg		42 kg	107234F		
			600	457		56 kg		43 kg	107236F	Drawer side	
			700	541		56 kg		43 kg	107238F	Metal: M4 / DIN 965 / ISO 7046	
									M4 / DIN 7500		
									Wood: 4,5 / DIN 7997		
TR - 3715 FINN 3			300	205		78 kg		60 kg	107239F	Cabinet side	
			350	239		63 kg		49 kg	107240F	Metal: M4 / DIN 7984	
			400	289		54 kg		42 kg	107241F	M5 / DIN 7985 / ISO 7045	
			450	339		46 kg		36 kg	107242F	M4 / M5 / ISO 7380	
			500	373		54 kg		42 kg	107243F	Wood: 5,0 / DIN 7997	
			600	457		56 kg		43 kg	107245F	Drawer side	
			700	541		56 kg		43 kg	107247F	Metal: M3 / DIN 7985 / ISO 7045	
									Wood: 3,0 / DIN 7997		
TR - 3727 FINN DOUBLE			315	395	vertical mounted				117270	Cabinet side	
						52 kg		40 kg		Metal: M4 / DIN 965 / ISO 7046	
					horizontal mounted						M4 / DIN 7500
											Wood: 4,0 / DIN 7997
									Drawer side		
									Metal: M4 / DIN 965 / ISO 7046		
									M4 / DIN 7500		
									Wood: 4,0 / DIN 7997		
TR - 4522 ADO			350	224	vertical mounted				105042	Cabinet side	
						91 kg		70 kg		Metal: M6 / DIN 965 / ISO 7046	
					horizontal mounted						Wood: 6,0 / DIN 7997
											Drawer side
									Metal: M4 / DIN 965 / ISO 7046		
									M4 / DIN 7500		
									Wood: 4,0 / 4,5 / DIN 7997		

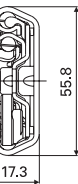

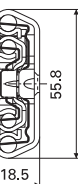





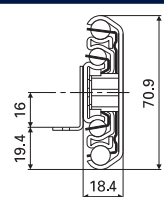
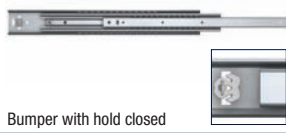
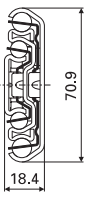

	telescopic slide full extension slides	technical drawing	description		load capacity		art. nr.	fixation
			length mm	travel mm	cycles 10.000	cycles 100.000		
TR - 5513 Solar S	 <p>Integrated soft close damper</p>		350	332	45 kg	38 kg	103R92F* 103R93F* 103R94F* 103R95F	Cabinet side Metal: M5 / DIN 965 Wood: 5,0 / DIN 7997 Drawer side Metal: M4 / DIN 965 Wood: 4,0 / 4,5 / DIN 7997
			400	400	55 kg	45 kg		
			450	450	60 kg	60 kg		
			500	505	60 kg	60 kg		
TR - 5619 ULF HD B	 <p>Drawer Carrier Bumper with hold closed</p>		300	320	94 kg	68 kg	112S01F 112S02F 112S03F 112S04F 112S05F 112S06F 112S07F 112S08F	Cabinet side Metal: M5 / DIN 965 / ISO 7046 M5 / DIN 7500 Wood: 5,0 / DIN 7997 Drawer side Metal: M3 / DIN 7985 / ISO 7045 Wood: 3,0 / DIN 7997
			350	375	96 kg	77 kg		
			400	440	97 kg	73 kg		
			450	495	110 kg	83 kg		
			500	550	119 kg	90 kg		
			550	600	118 kg	91 kg		
			600	650	123 kg	97 kg		
			700	750	129 kg	103 kg		
TR - 5617 ULF HD D	 <p>Bumper with hold closed</p>		300	320	94 kg	68 kg	112S21F 112S22F 112S23F 112S24F 112S25F 112S26F 112S27F 112S28F 112S29F 112S30F 112S31F	Cabinet side Metal: M5 / DIN 965 / ISO 7046 M5 / DIN 7500 Wood: 5,0 / DIN 7997 Drawer side Metal: M4 / DIN 965 / ISO 7046 M4 / DIN 7500 M4 / DIN 7991 / ISO 10462 Wood: 4,0 / 4,5 / DIN 7997
			350	375	96 kg	77 kg		
			400	440	97 kg	73 kg		
			450	495	110 kg	83 kg		
			500	550	119 kg	90 kg		
			550	600	118 kg	91 kg		
			600	650	123 kg	97 kg		
			700	750	129 kg	103 kg		
			800	848	121 kg	102 kg		
			900	950	105 kg	90 kg		
TR - 5620 ULF HD E	 <p>Drawer Carrier Pull in with fail-safe</p>		300	285	94 kg	64 kg	112S41F 112S42F 112S43F 112S44F 112S45F 112S46F 112S47F 112S48F 112S49F	Cabinet side Metal: M5 / DIN 965 / ISO 7046 M5 / DIN 7500 M5 / DIN 7991 / ISO 10462 Wood: 5,0 / DIN 7997 Drawer side Metal: M3 / DIN 7985 / ISO 7045 Wood: 3,0 / DIN 7997
			350	350	96 kg	73 kg		
			400	400	97 kg	77 kg		
			450	450	110 kg	88 kg		
			500	500	119 kg	90 kg		
			550	550	118 kg	98 kg		
			600	600	123 kg	99 kg		
			700	700	129 kg	103 kg		
			800	800	121 kg	106 kg		
TR - 5618 ULF HD F	 <p>Pull in with fail-safe</p>		300	285	94 kg	64 kg	112S61F 112S62F 112S63F 112S64F 112S65F 112S66F 112S67F 112S68F 112S69F	Cabinet side Metal: M5 / DIN 965 / ISO 7046 M5 / DIN 7500 M5 / DIN 7991 / ISO 10462 Wood: 5,0 / DIN 7997 Drawer side Metal: M4 / DIN 965 / ISO 7046 M4 / DIN 7500 M4 / DIN 7991 / ISO 10462 Wood: 4,0 / 4,5 / DIN 7997
			350	350	96 kg	73 kg		
			400	400	97 kg	77 kg		
			450	450	110 kg	88 kg		
			500	500	119 kg	90 kg		
			550	550	118 kg	98 kg		
			600	600	123 kg	99 kg		
			700	700	129 kg	103 kg		
800	800	121 kg	106 kg					
TR - 5618 ULF HD BILEX	 <p>100% extension on two sides</p>		500	503 - 503	114 kg	76 kg	112511F 112510F 112509F 112512F	Cabinet side Metal: M5 / DIN 965 / ISO 7046 M5 / DIN 7500 Wood: 5,0 / DIN 7997 Drawer side Metal: M4 / DIN 965 / ISO 7046 M4 / DIN 7500 Wood: 4,5 / DIN 7997
			600	607 - 607	119 kg	79 kg		
			700	711 - 711	131 kg	87 kg		
			800	815 - 815	138 kg	92 kg		
TR - 5619 ULF HD S	 <p>Integrated soft close damper</p>		350	335	65 kg	57 kg	112S82F 112S83F 112S84F 112S85F 112S86F 112S87F 112S88F	Cabinet side Metal: M5 / DIN 965 / ISO 7046 M5 / DIN 7500 M5 / DIN 7991 / ISO 10462 Wood: 5,0 / DIN 7997 Drawer side Metal: M4 / DIN 965 / ISO 7046 M4 / DIN 7500 M4 / DIN 7991 / ISO 10462 Wood: 4,0 / 4,5 / DIN 7997
			400	400	75 kg	68 kg		
			450	451	75 kg	75 kg		
			500	506	75 kg	75 kg		
			550	555	75 kg	75 kg		
			600	609	75 kg	75 kg		
			700	697	75 kg	75 kg		

* min. of 250 pair, lead time on request

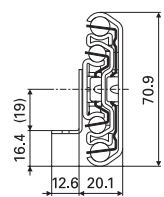

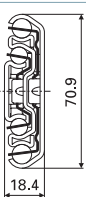
standard program

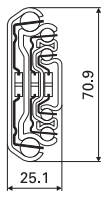

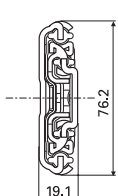

telescopic slides

	telescopic slide full extension slides	technical drawing	description					load capacity			art. nr.	fixation	
			length mm	travel mm	cycles 10.000	cycles 50.000	cycles 100.000						
TR - 7120 TITAN B	 <p>Drawer Carrier Bumper with hold closed</p>		400	435	157 kg			97 kg	101S03F	Cabinet side Metal: M5 / DIN 965 / ISO 7046 M5 / DIN 7500 Wood: 5,0 / DIN 7997			
			450	485	160 kg			103 kg	101S04F				
			500	545	169 kg			115 kg	101S05F				
											118 kg	101S06F	Drawer side Metal: M3 / DIN 7985 / ISO 7045 Wood: 3,0 / DIN 7997
										118 kg	101S07F		
										137 kg	101S08F		
TR - 7118 TITAN D	 <p>Bumper with hold closed</p>		400	435	157 kg			97 kg	101S23F	Cabinet side Metal: M5 / DIN 965 / ISO 7046 M5 / DIN 7500 Wood: 5,0 / DIN 7997			
			450	485	160 kg			103 kg	101S24F				
			500	545	169 kg			115 kg	101S25F				
											118 kg	101S26F	Drawer side Metal: M4 / DIN 965 / ISO 7046 M4 / DIN 7500 Wood: 4,0 / 4,5 / DIN 7997
										118 kg	101S27F		
										137 kg	101S28F		
										147 kg	101S29F		
								125 kg	101S30F				
								108 kg	101S31F				
TR - 7120 TITAN E	 <p>Drawer Carrier Pull in with fail-safe</p>		400	400	170 kg			103 kg	101S43F	Cabinet side Metal: M5 / DIN 965 / ISO 7046 M5 / DIN 7500 Wood: 5,0 / DIN 7997			
			450	450	190 kg			116 kg	101S44F				
			500	500	212 kg			125 kg	101S45F				
											140 kg	101S46F	Drawer side Metal: M3 / DIN 7985 / ISO 7045 Wood: 3,0 / DIN 7997
										145 kg	101S47F		
										145 kg	101S48F		
										155 kg	101S49F		
TR - 7118 TITAN F	 <p>Pull in with fail-safe</p>		400	400	170 kg			103 kg	101S63F	Cabinet side Metal: M5 / DIN 965 / ISO 7046 M5 / DIN 7500 Wood: 5,0 / DIN 7997			
			450	450	190 kg			116 kg	101S64F				
			500	500	212 kg			125 kg	101S65F				
											140 kg	101S66F	Drawer side Metal: M4 / DIN 965 / ISO 7046 M4 / DIN 7500 Wood: 4,0 / 4,5 / DIN 7997
										145 kg	101S67F		
										145 kg	101S68F		
										155 kg	101S69F		
TR - 7125 CONDOR	 <p>Bumper with hold closed</p>		300	395	80 kg				111M32F	Cabinet side Metal: M5 / DIN 965 / ISO 7046 M5 / DIN 7500 Wood: 5,0 / DIN 7997			
			400	595	90 kg						111M33F		
			500	750	90 kg						111M34F		
											100 kg	111M35F	Drawer side Metal: M4 / DIN 965 / ISO 7046 M4 / DIN 7500 M4 / DIN 7991 / ISO 10462 Wood: 4,0 / 4,5 / DIN 7997
										100 kg	111M36F		
										100 kg	111M37F		
											100 kg	111M38F	
TR - 7619 JUMBO	 <p>Bumper without hold closed Lock in / Lock out</p>		descript.		load capacity		art. nr. ***		fixation				
			L	T	cycles	cycles							
			mm	mm	10.000	50.000			with lock in left slide	with lock in right slide	with lock out	with lock in/out left slide	with lock in/out right slide
			300	298	225 kg	195 kg	114S31	AL	AR	B	DL	DR	Cabinet side Metal: M5 / DIN 7984 M5 / M6 / ISO 7380
			350	366	235 kg	200 kg	114S32	AL	AR	B	DL	DR	
			400	398	250 kg	210 kg	114S33	AL	AR	B	DL	DR	
			450	464	255 kg	220 kg	114S34	AL	AR	B	DL	DR	Drawer side Metal: M5 / DIN 7984 M5 / M6 / ISO 7380
			500	512	260 kg	230 kg	114S35	AL	AR	B	DL	DR	
			550	562	265 kg	240 kg	114S36	AL	AR	B	DL	DR	
			600	610	275 kg	255 kg	114S37	AL	AR	B	DL	DR	
			650	660	285 kg	265 kg	114S46	AL	AR	B	DL	DR	
			700	708	295 kg	280 kg	114S48	AL	AR	B	DL	DR	
			750	758	300 kg	290 kg	114S47	AL	AR	B	DL	DR	
			800	806	310 kg	300 kg	114S39	AL	AR	B	DL	DR	
			850	854	315 kg	300 kg	114S43	AL	AR	B	DL	DR	
			900	904	320 kg	310 kg	114S40	AL	AR	B	DL	DR	
			1000	1000	325 kg	315 kg	114S41	AL	AR	B	DL	DR	
1100	1098	305 kg	290 kg	114S44	AL	AR	B	DL	DR				
1200	1212	295 kg	280 kg	114S42	AL	AR	B	DL	DR				
1350	1358	245 kg	210 kg	114S48	AL	AR	B	DL	DR				
1500	1504	225 kg	195 kg	114S45	AL	AR	B	DL	DR				

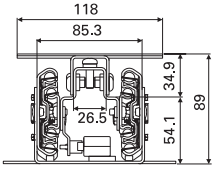

*** Add AL behind article number for "with lock in" on the left slide or AR for on the right slide.
Add B behind article number for "with lock out".
Add DL behind article number for "with lock in/out, front release" on the left slide or DR for on the right slide.

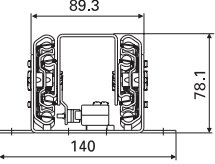
standard program

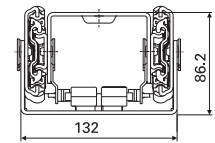
larder units and linear guides



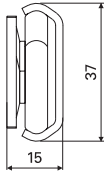
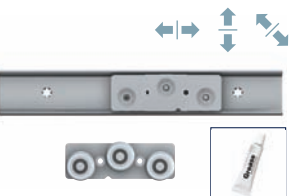
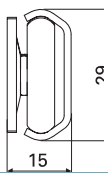

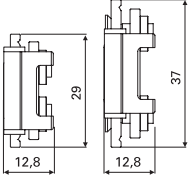



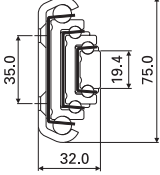

	larder units full extension slides	technical drawing	descript.		load cap.	art. nr.	art. nr.		art. nr.		art. nr.			
			L mm	T mm			cycles 10.000	L mm	T mm	T mm	L mm	T mm		
Larder Unit for Wood			bottom slide TITAN			top slide FINN roller		top slide U-guide		top slide ULF HD pin				
			425	425	80 - 120 kg	150A67	412	289	127A10	425	1556441	403	455	124B63
			485	485	80 - 120 kg	150A68	465	312	127A08	480	1556438	458	510	124B47
			585	585	80 - 120 kg	150A69	465	312	127A08	580	1556439	556	610	124B64
			750	750	80 - 120 kg	150A70	675	424	127A09	750	1556440	721	780	124B65
			optional bracket set			1539954								
Larder Unit for Steel			bottom slide TITAN KIT inclusive			top slide ULF HD pin		optional		top slide FINN roller				
			485	485	80 - 120 kg	150A71	403	455				412	289	127A10
			585	580	80 - 120 kg	150A72	458	510			465	312	127A08	
Larder Unit for Heavy duty			bottom slide JUMBO KIT inclusive			top slide ULF HD pin								
			650	650	300 kg	150A38								

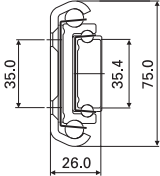
please visit our website www.thomasregout.com for more customized solutions

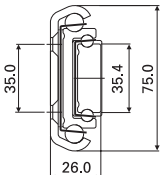

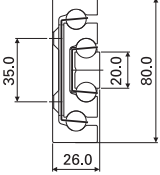

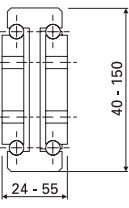

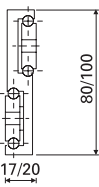
	linear guides	technical drawing	description		load cap.	art. nr.	fixation	
			length mm	travel mm				
FlexFit - 1537			3 wheel carrier		Rad. 800N	205S01	Cabinet side	
			5 wheel carrier		Rad. 1150N	205S02	Metal: M5 - 8.8 / DIN 7991 / ISO 10463	
			Profile	max 2394**	depending on length	on request	205S03	Wood: 5,0 / DIN 7997
			- galvanised steel		depending on length	on request	205S098	Drawer side
			- stainless steel	max 3994**	depending on length	on request	Metal: M5 / DIN 965 / ISO 7046	
					weight		M5 / DIN 7500	
			Grease gados S2		20 gram	16901223		
FlexFit - 1529			3 wheel carrier		Rad. 425N	205S05	Cabinet side	
			5 wheel carrier		Rad. 650N	205S06	Metal: M5 - 8.8 / DIN 7991 / ISO 10462	
			Profile	max 2394**	depending on length	on request	205S07	Wood: 5,0 / DIN 7997
			- galvanised steel		depending on length	on request	205S108	Drawer side
			- stainless steel	max 3994**	depending on length	on request	Metal: M5 / DIN 965 / ISO 7046	
					weight		M5 / DIN 7500	
			Grease gados S2		20 gram	16901223		
FlexFit Rubber Stop			Rubber Stop 1537	37x12,8x30		205S118	packed per pair	
			Rubber Stop 1529	29x12,8x30		205S128	packed per pair	

** customer specific available in all lengths

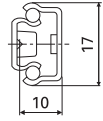
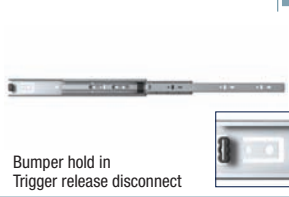
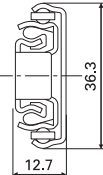

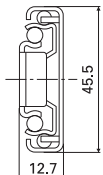
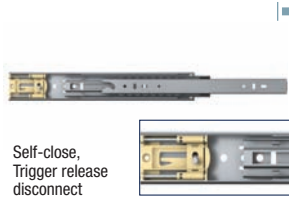
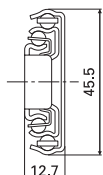
	heavy duty full extension slides	technical drawing	description		load capacity cycles 10.000	art. nr.	fixation
			length mm	travel mm			
TR - 7532 SUPRA			300	450	150 kg	13875S61	Cabinet side
			350	525	184 kg	13875S62	Metal: M5 / DIN 7991 / ISO 10462
			400	600	212 kg	13875S63	
			450	675	224 kg	13875S64	Drawer side
			500	750	232 kg	13875S65	Metal: M6 / DIN 7991 / ISO 10462
			550	825	240 kg	13875S66	
			600	900	250 kg	13875S67	
			650	975	235 kg	13875S68	
			700	1050	220 kg	13875S69	
			750	1125	200 kg	13875S70	
			800	1200	180 kg	13875S71	
			850	1275	160 kg	13875S72	
			900	1350	140 kg	13875S73	
			950	1425	120 kg	13875S74	
1000	1500	100 kg	13875S75				
TR - 7526 - 100 SUPRA	100% Extension 		300	310	360 kg	13875S01	Cabinet side
			350	360	380 kg	13875S02	Metal: M5 / DIN 7991 / ISO 10462
			400	410	390 kg	13875S03	
			450	460	400 kg	13875S04	Drawer side
			500	510	410 kg	13875S05	Metal: M8 / DIN 7991 / ISO 10462
			550	560	420 kg	13875S06	
			600	610	430 kg	13875S07	
			650	660	420 kg	13875S08	
			700	710	410 kg	13875S09	
			750	760	400 kg	13875S10	
			800	810	390 kg	13875S11	
			850	860	380 kg	13875S12	
			900	910	370 kg	13875S13	
			950	960	360 kg	13875S14	
1000	1010	350 kg	13875S15				
TR - 7526 - 120 SUPRA	120% Extension 		300	360	324 kg	13875S31	Cabinet side
			350	420	342 kg	13875S32	Metal: M5 / DIN 7991 / ISO 10462
			400	480	351 kg	13875S33	
			450	540	360 kg	13875S34	Drawer side
			500	600	396 kg	13875S35	Metal: M8 / DIN 7991 / ISO 10462
			550	660	378 kg	13875S36	
			600	720	387 kg	13875S37	
			650	780	378 kg	13875S38	
			700	840	369 kg	13875S39	
			750	900	360 kg	13875S40	
			800	960	350 kg	13875S41	
			850	1030	342 kg	13875S42	
			900	1080	333 kg	13875S43	
			950	1140	324 kg	13875S44	
1000	1200	315 kg	13875S45				
TR - 8026 ALU SUPRA			300	285	250 kg	13880S01	Cabinet side
			350	335	260 kg	13880S02	Metal: M5 / DIN 7991 / ISO 10462
			400	385	270 kg	13880S03	
			450	435	280 kg	13880S04	Drawer side
			500	485	300 kg	13880S05	Metal: M8 / DIN 7991 / ISO 10462
			550	535	320 kg	13880S06	
			600	585	330 kg	13880S07	
			650	635	315 kg	13880S08	
			700	685	300 kg	13880S09	
			750	735	290 kg	13880S10	
			800	785	280 kg	13880S11	
850	835	270 kg	13880S12				
900	885	260 kg	13880S13				
950	935	250 kg	13880S14				
1000	985	240 kg	13880S15				
SUPREME	 <ul style="list-style-type: none">• Steel• Aluminium• Stainless steel 		length / extension 200 - 1200 mm load capacity 50 - 2100 kg		More information; check our complete Supreme program on www.thomasregout.com or ask our sales team.		
SUPREME S-design slide	 		length / extension 200 - 1200 mm load capacity 150 - 420 kg		More information; check our complete Supreme program on www.thomasregout.com or ask our sales team.		

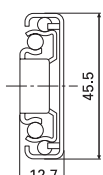

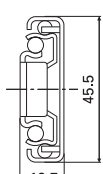











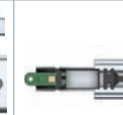











	telescopic slide full extension slides	technical drawing	description		load capacity			art. nr.	fixation			
			length mm	travel mm	cycles 10.000	cycles 50.000	cycles 100.000					
TRA - 1710 JUNIOR			178	129	8 kg	5 kg		13617S07	screw mount			
			182	133	8 kg	5 kg		13617S08	screw mount			
			214	140	8 kg	5 kg		13617S09	screw mount			
			246	172	11 kg	8 kg		13617S10	screw mount			
			278	204	11 kg	8 kg		13617S11	screw mount			
			310	212	13 kg	10 kg		13617S02	screw mount			
			342	244	13 kg	10 kg		13617S03	screw mount			
			374	276	11 kg	8 kg		13617S11	screw mount			
			406	308	11 kg	8 kg		13617S04	screw mount			
			438	318	10 kg	7 kg		13617S05	screw mount			
			470	350	8 kg	5 kg		13617S12	screw mount			
			502	382	8 kg	5 kg		13617S06	screw mount			
TRA - 3613SD ALLMAN			250	250	20 kg	18 kg	15 kg	13636S00	Cabinet side			
			300	300	20 kg	18 kg	15 kg	13636S01	Metal: M3 / M4 / ISO 7380			
			350	350	22 kg	20 kg	18 kg	13636S02	Wood: 2,9 / DIN 7981 / ISO 7049			
			400	400	25 kg	22 kg	20 kg	13636S03				
			450	450	25 kg	22 kg	20 kg	13636S04	Drawer side:			
			500	500	22 kg	20 kg	18 kg	13636S05	Metal: M3 / DIN 7984			
			550	550	22 kg	20 kg	18 kg	13636S06	M3 / DIN 7985 / ISO 7045			
			600	600	20 kg	18 kg	15 kg	13636S07	M4 / ISO 7380			
			650	650	20 kg	18 kg	15 kg	13636S08	Wood: 2,9 / DIN 7981 / ISO 7049			
			700	700	20 kg	18 kg	15 kg	13636S09				
TRA - 4613SD STEN			250	250	45 kg	38 kg	32 kg	13645S20	Cabinet side			
			300	300	46 kg	40 kg	34 kg	13645S21	Metal: M4 / DIN 7984			
			350	350	48 kg	42 kg	36 kg	13645S22	M3 / DIN 7985 / ISO 7045			
			400	400	51 kg	45 kg	39 kg	13645S23	M4 / ISO 7380			
			450	450	51 kg	45 kg	39 kg	13645S24	Wood: 3,5 / DIN 7981 / ISO 7049			
			500	500	48 kg	42 kg	36 kg	13645S25				
			550	550	46 kg	40 kg	34 kg	13645S26	Drawer side			
			600	600	44 kg	40 kg	34 kg	13645S27	Metal: M4 / ISO 7380			
			650	650	42 kg	38 kg	32 kg	13645S28	Wood: 3,5 / DIN 7981 / ISO 7049			
			700	700	42 kg	38 kg	32 kg	13645S29				
TRA - 4613CL STEN			300	300	33 kg	30 kg	24 kg	13645S41	Cabinet side			
			350	350	38 kg	35 kg	29 kg	13645S42	Metal: M4 / DIN 7984			
			400	400	43 kg	40 kg	34 kg	13645S43	M3 / DIN 7985 / ISO 7045			
			450	450	43 kg	40 kg	34 kg	13645S44	M4 / ISO 7380			
			500	500	38 kg	35 kg	29 kg	13645S45	Wood: 3,5 / DIN 7981 / ISO 7049			
			550	550	33 kg	30 kg	24 kg	13645S46				
			600	600	32 kg	30 kg	24 kg	13645S47	Drawer side			
			650	650	30 kg	28 kg	22 kg	13645S48	Metal: M3 / DIN 7984			
			700	700	30 kg	28 kg	22 kg	13645S49	M3 / DIN 7985 / ISO 7045			
			TRA - 4613SMC STEN			300	250	26 kg	20 kg	14 kg	13645S61	Cabinet side
350	320	26 kg				20 kg	14 kg	13645S62	Metal: M4 / DIN 7984			
400	375	31 kg				25 kg	19 kg	13645S63	M3 / DIN 7985 / ISO 7045			
450	450	36 kg				30 kg	24 kg	13645S64	M4 / ISO 7380			
500	500	36 kg				30 kg	24 kg	13645S65	Wood: 3,5 / DIN 7981 / ISO 7049			
550	550	31 kg				25 kg	19 kg	13645S66				
600	600	31 kg				25 kg	19 kg	13645S67	Drawer side			
650	650	26 kg				20 kg	14 kg	13645S68	Metal: M3 / DIN 7984			
TRA - 4613PO STEN						350	350	38 kg	35 kg	29 kg	13645S82	Cabinet side
						400	400	43 kg	40 kg	34 kg	13645S83	Metal: M4 / DIN 7984
			450	450	43 kg	40 kg	34 kg	13645S84	M3 / DIN 7985 / ISO 7045			
			500	500	38 kg	35 kg	29 kg	13645S85	M4 / ISO 7380			
			550	550	33 kg	30 kg	24 kg	13645S86	Wood: 3,5 / DIN 7981 / ISO 7049			
			600	600	30 kg	24 kg	20 kg	13645S87				
			650	650	30 kg	24 kg	20 kg	13645S88	Drawer side			

02.7.9 Insteekkaart The information in this leaflet can be subject to changes.

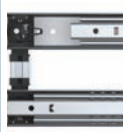

features, fixations, systems and surface treatments

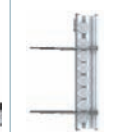
FEATURES	Bumper without hold closed	Bumper with hold closed	Hold out	Hold out disconnection inner profile	Lock out disconnection inner profile	Lock in / horizontal latch front release	Lock in / vertical latch front release	Soft close damper integrated	Soft close damper outside
									
FIXATIONS	Pull in 30N 22mm	Pull in 42N 35mm	Pull in 54N 22mm	Electric Discharging	Push to open				
									
SYSTEMS	Holes	Countersunk holes	Press inserts	Studs	Studs threaded	Tabs / Bajonets	Slotted strip bracket	Spacer bracket	Drawer carrier
							 spotwelded	 spotwelded	 spotwelded
SURFACE TREATMENTS	Larder Unit	ISL Integrated slide lock	ISL lock	Rack and Pinion	UDL				
									
<ul style="list-style-type: none"> • Bright zinc chromate, black passivation, up to 120 hours (white corrosion), organic / inorganic leachant sealant NEN EN-ISO 9227 / ASTM-B117) • Bright zinc chromate, blue passivation up to 96 hours (white corrosion), organic / inorganic leachant sealant NEN EN-ISO 9227 / ASTM-B117) • Pre- galvanized (Sendzimir) 									

